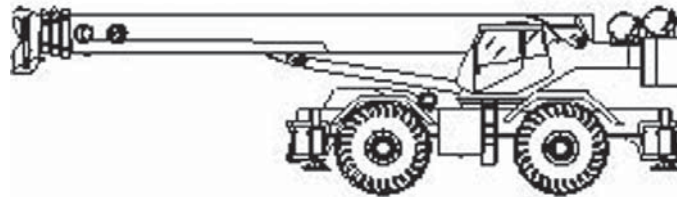

Rough Terrain Crane Specifications | RT500-1 Series**STANDARD BOOM EQUIPMENT****BOOM**

35-110' (10.67-33.53 m), four section full power boom. Telescoping is mechanically synchronized with single lever control. The synchronization system consists of a single telescope cylinder and high strength leaf chains to extend and retract the third section and the tip section. The boom is a high-strength four plate design, welded inside and out with anti-friction slide pads. Boom side plates are made with stamped impressions to reduce weight and increase strength.

BOOM HEAD

Welded to fourth section of boom. Five or six metallic load sheaves and two idler sheaves mounted on heavy duty, anti-friction bearings. Quick reeving boom head. Provision made for side-stow jib mounting.

OPTIONAL BOOM EQUIPMENT**JIBS**

Jibs feature easy installation/stowage through use of spear type stowage system. Jibs utilize a single metallic sheave mounted on anti-friction bearing. Jibs are quickly offsettable at 0°, 15° or 30° by relocating two pins. 32' (9.68 m) side stow swing-on one piece lattice type jib. Maximum tip height is 146' (44.5 m), 33-37' (10.15-17.30 m) side stow swing-on lattice type jib. Jib is extendable to 57' (17.30 m) by means of a 25' (7.62 m) manual pull-out tip section, roller supported for ease of extension. Maximum tip height is 170' (51.82 m). Stub head allows removal of pull-out from 33-57' jib, allowing it to function as a 32' swing-on with improved chart at longer radii when extra jib length is not required.

A single boom hoist cylinder provides for boom elevation of -4 to 76°. Maximum tip height 115' (35.05 m).

AUXILIARY BOOM HEAD

Removable auxiliary boom head has single metallic sheave mounted on anti-friction bearing. Removable pin-type rope guard for quick reeving. Installs on main boom peak only. Removable is not required for jib use.

HOOK BLOCK

Five or six metallic sheaves on anti-friction bearings with hook and hook latch. Quick reeving design does not require removal of wedge and socket from rope.

HOOK AND BALL

7 ton (6.3 mt) top swivel ball with hook and hook latch.

STANDARD UPPERSTRUCTURE EQUIPMENT
UPPERSTRUCTURE FRAME

All welded one-piece structure fabricated with high tensile strength alloy steel. Counterweight is bolted to frame.

TURNTABLE CONNECTION

Swing bearing is a single row, ball type, with internal teeth. The swing bearing is bolted to the revolving upperstructure and to the carrier frame.

SWING

A hydraulic motor drives a double planetary reduction gear for precise and smooth swing function. Swing speed (no load) is two rpm.

SWING BRAKE

Heavy duty multiple disc swing brake is mechanically actuated from operator's cab by foot pedal. Brake may be locked on or used as a momentary brake. Air operated 360° mechanical house lock is standard.

RATED CAPACITY INDICATOR

Rated Capacity Indicator with visual and audible warning system and automatic function disconnects. Second generation pictographic display includes: boom radius, boom angle, boom length, allowable load, actual load and percentage of allowable load registered by bar graph. Operator settable alarms provided for swing angle, boom length, boom angle, tip height and work area exclusion zone. Anti-two block system includes audio/visual warning and automatic function disconnects.

OPERATORS CAB

Environmental cab with all steel construction, optimum visibility, tinted safety glass throughout and rubber floor matting is mounted on vibration absorbing pads. The cab has a sliding door on the left side, framed sliding window on the right side, hinged tinted all glass skylight and removable front windshield to provide optimum visibility of the load open or closed. Acoustical foam padding insulates against sound and weather. The deluxe six-way adjustable seat is equipped with a mechanical suspension and includes head and arm rests.

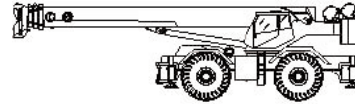
CONTROLS

All control levers and pedals are positioned for efficient operation. Armrest mounted dual axis controls for winch(s), swing, and boom elevation, winch rotation indication incorporated into control handles. Armrest swings up to improve access and egress. Vernier adjustable hand throttle included. Steering column mounted turn signal, wiper, and shift controls. Winches include ignition, engine stop, lights, horn, roof window wiper, hot air defroster, steering mode, parking brake, outriggers, 360° house lock. Horn and winch speed shift switches are mounted in the levers. Foot control pedals include swing brake, boom telescope, service brake and accelerator.

INSTRUMENTATION AND ACCESSORIES

In-cab gauges include air pressure, bubble level, engine oil pressure, fuel, engine temperature, voltmeter, transmission temperature and transmission oil pressure. Indicators include low air, high water temperature, low oil pressure, high transmission temperature and low coolant level audio/visual warning, hoist drum rotation indicator(s) and Rated Capacity Indicator. Accessories include fire extinguisher; light package including headlights, tail light, brake lights, directional signals, four-way hazard flashers, dome light and back-up lights with audible back-up alarm; windshield washer/wiper; skylight wipers; R.H. and L.H. rear view mirrors; dash lights; and seat belt. Circuit breakers protect electrical circuits.

HYDRAULIC CONTROL VALVES

Valves are mounted on the rear of the upperstructure and are easily accessible. Valves have electric/hydraulic operators and include one pressure compensated two spool valve for main and auxiliary winch, and one single spool valve for swing. Quick disconnects are provided for ease of installation of pressure check gauges

OPTIONAL EQUIPMENT

Auxiliary Winch, Heater/Defroster, hydraulically powered Air Conditioner with or without hydraulic heater, LP or Diesel Heater/Defroster, Tachometer, Work Lights, Rotating Beacon

STANDARD CARRIER EQUIPMENT
CARRIER CHASSIS

Chassis is Terex designed with four-wheel drive and four-wheel steer (4X4X4). Has box-type construction with reinforcing cross members, a precision machined turn table mounting plate and integrally welded outrigger boxers. Decking has anti-skid surfaces, including between the frame rails lockable front tool storage compartment and access steps and handles on the left and right sides and on all four corners.

AXLES AND SUSPENSION

Rear axle is a planetary drive/steer type with 10.5" (0.26 m) of total oscillation. Automatic oscillation lockouts that engage when the superstructure is swung 10° in either direction. Front axle is a planetary drive/steer type, rigid mounted to the frame for increased stability.

STEERING

Hydraulic four-wheel full power steering for two-wheel, four-wheel coordinated, or four-wheel crab steer is easily controlled by steering wheel. A rear axle centering light is provided. Turning radius to center of outside tire.

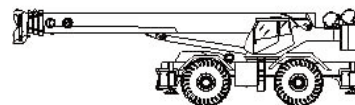

	Turning Radius: (to CL of outside tire)	Curb Clearance Radius
Two-wheel:	40' 4" (12.3 m)	40' (12.2 m)
Four-wheel:	23' 4" (7.1 m)	23' (7 m)

TRANSMISSION

Range-shift type power-shift transmission with integral torque converter has neutral safety start, six speeds forward and six speeds reverse provides wide ratio coverage. Automatic pulsating back-up alarm.



STANDARD CARRIER EQUIPMENT (CONTINUED)

**MULTI-POSITION OUT AND DOWN
OUTRIGGERS**

Fully independent hydraulic outriggers may be utilized fully extended to 22' (6.71 m) centerline to centerline, in their 1/2 extended position, or fully retracted for maximum flexibility. Easily removable aluminum floats, each with an area of 452 in² (2 919 cm²), stow on the outrigger boxes at their point of use. Complete controls and a sight leveling bubble are located in the operator's cab.

WHEELS AND TIRES

Disk type wheels with full tapered bead seat rim. 150.5" (3.82 m) wheelbase.

TIRES

Wide earthmover (E3) style tread tires provide life and flotation.
26.5x25, 26 P.R. – std.
21x25, 28 P.R. – opt.

SERVICE BRAKES

Split system air over hydraulic brakes on all four wheels, 18.5" diameter disc dual caliper brakes on front wheels and single caliper brakes on rear axle.

PARKING BRAKE

Front axle equipped with spring-set, air released emergency/parking brake.

OPTIONAL EQUIPMENT

Immersion Heater, Pintle Hook(s), Clearance Lights, Independent Rear Steering, Four Mode Rear Wheel Steer, 20,000 lb line pull front mounted winch.

HYDRAULIC SYSTEM

HYDRAULIC PUMPS

Three gear type pumps, one in single and two tandem pumps, driven off the transmission. Combined system capability is 147 gpm (557 lpm). Includes pump disconnect on winch and tandem pump.

- ▶ **Main winch pump**
- ▶ 55.3 gpm (209.3 lpm) @ 3,500 psi (246.1 kg/cm²)
- ▶ **Boom Hoist and Telescope Pump**
- ▶ 39.1 gpm (148 lpm) @ 3,500 psi (246.1 kg/cm²)
- ▶ **Power Steering, Outrigger and Winch Boost Pump**
- ▶ 19.6 gpm (74.2 lpm) @ 2,500 psi (175 kg/cm²)

FILTRATION

Full flow oil filtration system with bypass protection includes a removable 60 mesh (250 micron) suction screen-type filter and five micron replaceable return line filter.

HYDRAULIC RESERVOIR

All steel, welded construction with internal baffles and a diffuser. Provides easy access to filters and is equipped with an external sight level gauge. The hydraulic tank is pressurized to aid in keeping out contaminants and in reducing potential pump cavitation. Capacity is 112 gal (424 L). Hydraulic oil cooler is standard.

MAIN WINCH SPECIFICATIONS

Hydraulic winch with bent axis piston and planetary reduction gearing provides two-speed operation with equal speeds for power up and down. Winch is equipped with an integral automatic brake, grooved drum, tapered flanges, standard cable roller on drum, and an electric drum rotation indicator.

Performance	LO-Range	HI-Range
▶ Max line speed (no load)		
▶ First Layer	171 fpm (52.21 m/min)	343 fpm (104.5 m/min)
▶ Fifth Layer	248 fpm (75.6 m/min)	496 fpm (151.2 m/min)
<hr/>		
▶ Max. line pull-first layer	15,639 lb (7 093 kg)	7,298 lb (3 310 kg)
▶ Max. line pull-fifth layer	10,827 lb (4 911 kg)	5,052 lb (2 291 kg)
▶ Permissible line pull	11,250 lb (5 102 kg)	

Drum Dimensions	Drum Capacity
▶ 10.62" (270 mm) drum diameter	Max. Storage: 939' (286.2 m)
▶ 22.42" (570 mm) length	7th layer not a working layer
▶ 20" (508 mm) flange dia.	Max. Useable: 772' (235.3 m)*
▶ Cable: 5/8" x 500' (16 mm x 152.4 m)	
▶ Cable type: 5/8" x (16 mm) 6x19 IWRC,	
▶ XIPS, right regular lay, performed	
*Based on minimum flange height above top layer to comply with ANSI B30.5	

OPTIONAL HOIST LINE

Main winch and optional auxiliary winch: 5/8" (16 mm) rotation resistant compacted strand 34x7. Min breaking strength 28.21 tons (25.59 mt)

OPTIONAL AUXILIARY WINCH

Hydraulic 2-speed winch with bent axis piston motor, equal speed power up and down, planetary reduction with integral automatic brake, grooved drum with tapered flanges, drum roller, and rotation indicator.

Performance	
▶ Max. line speed (no load) Fifth layer	496 fpm (151.2 m/min)
▶ Max. line pull First layer	15,639 lb (7 093 kg)

Drum Dimensions and Capacity (Same as main winch)

ENGINE SPECIFICATIONS

- ▶ Make and Model Cummins QSB185
- ▶ Type 6 cylinder
- ▶ Bore and Stroke 4.02 x 4.72" (102x120 mm)
- ▶ Displacement 360 cubic inches (5.91)
- ▶ Rated HP 185 hp (138 kw) @ 2400 rpm
- ▶ Maximum HP 190 hp (142 kw) @ 2300 rpm
- ▶ Rated Torque 548 lb•ft(743 N•m) @ 1400 rpm
- ▶ Aspiration turbocharged & charge air cooled
- ▶ Air Filter dry type
- ▶ Electrical System 12 volt
- ▶ Alternator 100 amp
- ▶ Battery (2) 12V-1600 CCA
- ▶ Fuel Capacity 80 gal (303 L)

PERFORMANCE (STANDARD ENGINE)

Trans-mission Gear	Forward Drive	Max. Speed	Max. Tractive Effort	Grade-ability @ Stall
▶ Low 1	4-wheel	1.4 mph (2.7 kph)	102,809 lb (32 681 kg)	>100%
▶ Low 2	4-wheel	3.0 mph (6.0 kph)	49,473 lb (15 456 kg)	73.2%
▶ Low 3	4-wheel	8.2 mph (10.3 kph)	18,097 lb (8 909 kg)	20.7%
▶ High 1	2-wheel	4.2 mph (16.7 kph)	35,348 lb (5 525 kg)	45.7%
▶ High 2	2-wheel	8.8 mph (6.9 kph)	16,957 lb (13 226 kg)	19.2%
▶ High 3	2-wheel	22.8 mph (14.8 kph)	6,179 lb (6 250 kg)	5.6%

All performance data is based on a gross vehicle weight of 81,000 lb (36 741 kg). 26.5x25 tires, 4x4 drive. Performance may vary due to engine performance. Gradeability data is theoretical and is limited by tire slip, machine stability, or oil pan design.



GENERAL DIMENSIONS

1. Dimensions given assume the boom is fully retracted in travel position and 26.50 x 25 tires.

2. Minimum ground clearance under transmission: - 25.25"

axle bowls - 22.25"

tie rods - 25.5"

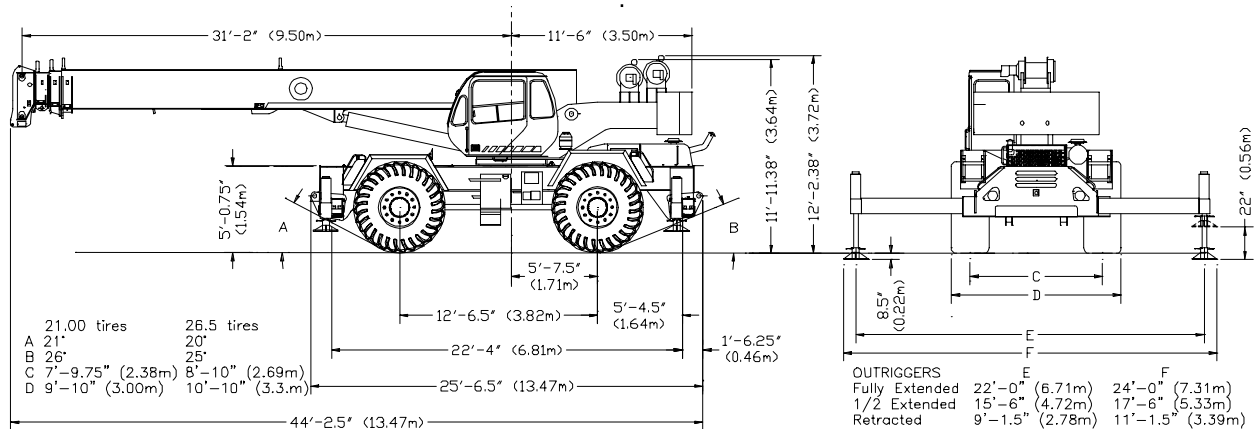

WEIGHTS & AXLE LOADS	GROSS WEIGHT LB	UPPER FACING FRONT		GROSS WEIGHT KG	UPPER FACING FRONT	
		FRONT	REAR		FRONT	REAR
Base Crane with 14,200 lb (6 440 kg) Counterweight	76,832	40,040	36,792	34,850	18,162	16,688
Add Options:						
32' (9.68 m) Swing-on Jib (Stowed)	+ 1,260	+ 2,130	- 870	+ 572	+ 966	- 394
33' - 57' (10.5 - 17.30 m) Swing-on Jib (Stowed)	+ 2,160	+ 3,600	- 1,440	+ 980	+ 1,633	- 653
Auxiliary Boom Head	+ 100	+ 300	- 230	+ 45	+ 136	- 91
Auxiliary Winch Controls and Plumbing Only	+ 75	+ 0	+ 75	+ 34	+ 0	+ 34
Auxiliary Winch with Wire Rope, Controls, Etc.	+ 264	- 60	+ 204	+ 120	- 27	+ 93
55T (49.9 mt) 6-Sheave Hook Block	+ 755	+ 1,130	- 375	+ 342	+ 512	- 170
55T (49.9 mt) 5-Sheave Hook Block	+ 723	+ 1,080	- 357	+ 328	+ 490	- 162
25T (22.7 mt) 2-Sheave Hook Block	+ 240	+ 290	- 50	+ 109	+ 130	- 21
7T (6.35 mt)	+ 580	+ 870	- 290	+ 263	+ 395	- 132
Pintle Hook:						
Front	+ 45	+ 60	- 15	+ 20	+ 27	+ 7
Rear	+ 45	- 25	+ 70	+ 20	- 11	- 31
Substitute:						
21.00x25 28 PR Tires	- 400	- 200	- 200	- 182	- 91	- 91
500' of 34x7 class spin resistant wire rope	+ 65	- 42	+ 107	+ 30	+ 19	+ 49

Note: Weights are for Terex supplied equipment and are subject to 2% variation due to manufacturing tolerances.

TEREX Cranes
106-12th Street S.E.
Waverly, Iowa 50677-9466 USA

TEL (319) 352-3920 FAX (319) 352-5727
EMAIL inquire@terexwaverly.com
WEB terex.com

WE RESERVE THE RIGHT TO AMEND THESE SPECIFICATIONS AT ANY TIME WITHOUT NOTICE. THE ONLY WARRANTY APPLICABLE IS OUR STANDARD WRITTEN WARRANTY APPLICABLE TO THE PARTICULAR PRODUCT AND SALE. WE MAKE NO OTHER WARRANTY, EXPRESSED OR IMPLIED.



Range Diagram and Lifting Capacity | RT555-1

55 TON LIFTING CAPACITY

RANGE DIAGRAM 33' - 110' BOOM

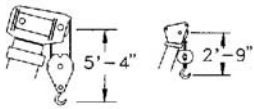

Dimensions are for largest factory furnished hook block and hook & ball, with anti-two block activated

COUNTER WEIGHT	W/AUX. WINCH 13,100 LB W/O AUX. WINCH 14,200 LB
BOOM LENGTH	33'-110'
OUTRIGGER SPREAD	22'
STABILITY PERCENTAGE	ON OUTRIGGERS 85% ON TIRES 75%
PCSA CLASS	10-210

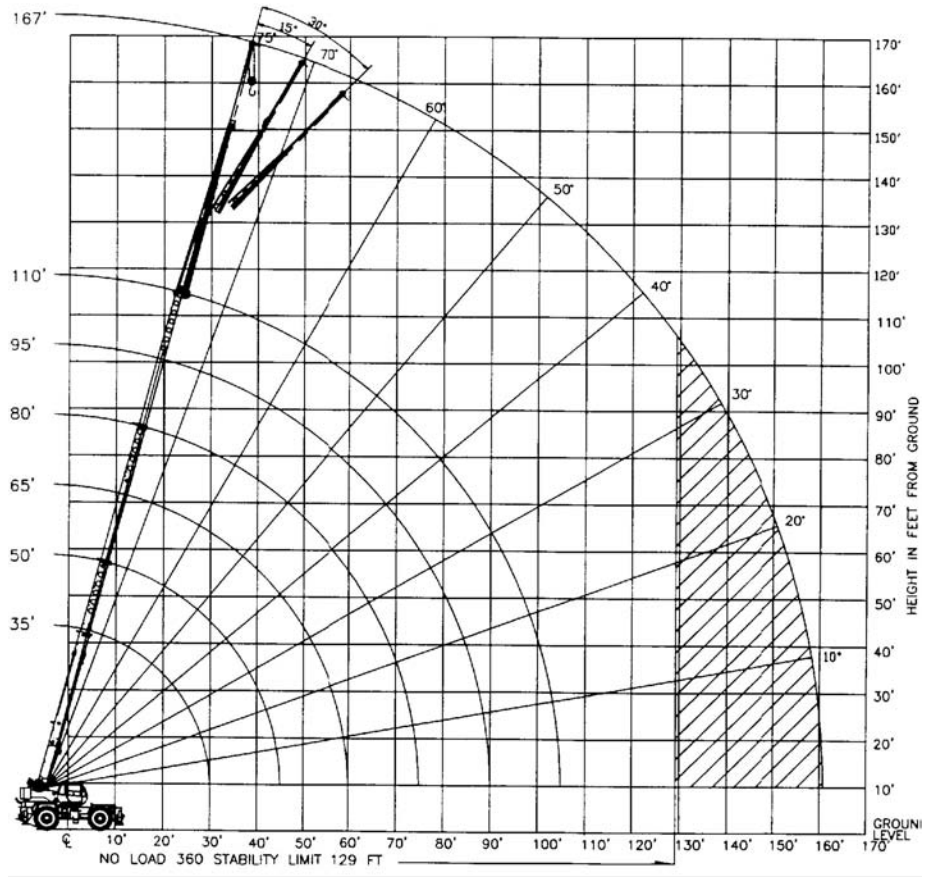

CRANE WORKING CONDITIONS

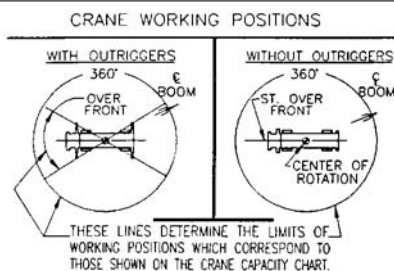

REDUCTION IN MAIN BOOM CAPACITY

All jib in stowed position	0 lb
Aux. boom in head sheave	100lb

HOOK BLOCK WEIGHTS

Hook and ball	239 lb
25T hook block (4 sheave)	690 lb
30T hook block (5 sheave)	888 lb
40T hook block (6 sheave)	913 lb



LIFTING CAPACITIES **CAUTION:** Do not use this specification sheet as a load rating chart. The format of data is not consistent with the machine chart and may be subject to change

ON OUTRIGGERS - FULLY EXTENDED

LOAD RADIUS (FT)	BOOM LENGTH 35'			BOOM LENGTH 50'			BOOM LENGTH 65'			LOAD RADIUS (FT)
	BOOM ANGLE (DEG) REF.	OVER FRONT (LB)	360° (LB)	BOOM ANGLE (DEG) REF.	OVER FRONT (LB)	360° (LB)	BOOM ANGLE (DEG) REF.	OVER FRONT (LB)	360° (LB)	
10	66.7	110,000*	110,000*	73.9	60,100*	60,100*				10
12	63.1	96,700*	93,700*	71.5	60,100*	60,100*				12
15	57.5	75,200*	73,100*	69.7	60,100*	60,100*	73.2	58,800*	58,800*	15
20	47.1	53,600*	52,300*	61.5	54,900*	53,600*	68.5	52,200*	52,200*	20
25	34.5	40,700*	39,700*	54.8	42,000*	41,100*	63.7	42,700*	41,700*	25
30	14.8	31,900*	31,200*	47.4	33,400*	32,700*	58.6	34,100*	33,400*	30
35	**			39.0	27,300*	26,700*	53.3	28,000*	27,400*	35
40				28.8	22,000	21,000	47.6	22,700	21,700	40
45				12.4	17,400	16,500	41.3	18,300	17,400	45
50				**			34.1	14,900	14,200	50
55							25.2	12,300	11,700	55
60							10.9	10,100	9,600	60
65							**			65
70										70
75										75
80										80
85										85
90										90
95										95
100										100
105										105
110										110

USE THESE CHARTS ONLY WHEN ALL OUTRIGGERS ARE FULLY EXTENDED

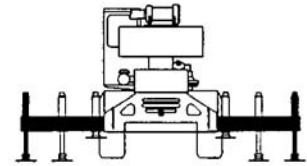



LIFTING CAPACITIES **CAUTION:** Do not use this specification sheet as a load rating chart. The format of data is not consistent with the machine chart and may be subject to change

ON OUTRIGGERS - FULLY EXTENDED

LOAD RADIUS (FT)	BOOM LENGTH 80'			BOOM LENGTH 95'			BOOM LENGTH 110'			LOAD RADIUS (FT)
	BOOM ANGLE (DEG) REF.	OVER FRONT (LB)	360° (LB)	BOOM ANGLE (DEG) REF.	OVER FRONT (LB)	360° (LB)	BOOM ANGLE (DEG) REF.	OVER FRONT (LB)	360° (LB)	
10										10
12										12
15										15
20	72.7	38,700*	38,700*							20
25	68.9	33,600*	33,600*	72.3	29,300*	29,300*				25
30	65.0	29,600*	29,600*	69.1	25,900*	25,900*	72.1	22,900*	22,900*	30
35	61.0	26,500*	26,500*	65.9	23,000*	23,000*	69.3	20,500*	20,500*	35
40	56.8	23,000	22,000	62.5	20,800*	20,800*	66.5	18,400*	18,400*	40
45	52.4	18,600	17,700	59.1	18,800	17,900	63.6	16,500*	16,500*	45
50	47.7	15,300	14,600	55.5	15,500	14,800	60.7	14,900*	14,900	50
55	42.7	12,700	12,100	51.7	12,900	12,300	57.7	13,000	12,400	55
60	37.1	10,700	10,100	47.8	10,900	10,400	54.5	11,000	10,500	60
65	30.6	9,000	8,500	43.6	9,200	8,800	51.3	9,400	8,900	65
70	22.6	7,500	7,100	39.0	7,900	7,400	47.8	8,000	7,600	70
75	9.8	6,300	5,900	33.9	6,700	6,300	44.2	6,800	6,500	75
80	**			28.1	5,700	5,300	40.4	5,900	5,500	80
85				20.8	4,800	4,400	36.1	5,000	4,700	85
90				9.0	3,900	3,600	31.5	4,200	3,900	90
95				**			26.5	3,500	3,200	95
100							19.3	2,900	2,400	100
105							8.4	2,300	2,100	105
110							**			110

****MAXIMUM CAPACITY AT 0 DEGREE BOOM ANGLE**

BOOM LENGTH 35'			BOOM LENGTH 50'			BOOM LENGTH 65'			BOOM LENGTH 80'			BOOM LENGTH 95'			BOOM LENGTH 110'		
LOAD RADIUS (FT)	OVER FRONT (LB)	360° (LB)	LOAD RADIUS (FT)	OVER FRONT (LB)	360° (LB)	LOAD RADIUS (FT)	OVER FRONT (LB)	360° (LB)	LOAD RADIUS (FT)	OVER FRONT (LB)	360° (LB)	LOAD RADIUS (FT)	OVER FRONT (LB)	360° (LB)	LOAD RADIUS (FT)	OVER FRONT (LB)	360° (LB)
31.2	20,900*	20,800	46.2	12,600	12,700	61.2	8,200	8,200	76.2	5,400	5,400	91.2	3,500	3,300	106.17	2,100	1,800

LIFTING CAPACITIES CAUTION: Do not use this specification sheet as a load rating chart. The format of data is not consistent with the machine chart and may be subject to change

ON OUTRIGGERS - MID POSITION

LOAD RADIUS (FT)	BOOM LENGTH 35'		BOOM LENGTH 50'		BOOM LENGTH 65'		BOOM LENGTH 80'		BOOM LENGTH 95'		BOOM LENGTH 110'		LOAD RADIUS (FT)
	BOOM ANGLE (DEG) REF.	360° (LB)	BOOM ANGLE (DEG) REF.	360° (LB)	BOOM ANGLE (DEG) REF.	360° (LB)	BOOM ANGLE (DEG) REF.	360° (LB)	BOOM ANGLE (DEG) REF.	360° (LB)	BOOM ANGLE (DEG) REF.	360° (LB)	
10	66.7	87,600	73.9	60,100*									10
12	63.1	71,400	71.5	60,100*									12
15	57.5	55,200	67.9	56,500*	73.2	57,200*							15
20	47.1	38,900	61.5	40,200*	68.5	40,800*	72.7	38,700*					20
25	34.5	25,800	54.8	27,300	63.7	27,900	68.9	28,200	72.3	28,400			25
30	14.8	17,700	47.4	19,400	58.6	19,900	65.0	20,200	69.1	20,400	72.1	20,600	30
35	**		39.0	14,200	53.3	14,900	61.0	15,200	65.9	15,400	69.3	15,500	35
40			28.8	10,700	47.6	11,400	56.8	11,800	62.5	11,900	66.5	12,100	40
45			12.4	8,000	41.3	8,800	52.4	9,200	59.1	9,400	63.6	9,500	45
50			**		34.1	6,800	47.7	7,200	55.5	7,500	60.7	7,600	50
55					25.2	5,200	42.7	5,700	51.7	5,900	57.7	6,000	55
60					10.9	3,800	37.1	4,400	47.8	4,700	54.5	4,800	60
65					**		30.6	3,300	43.6	3,600	51.3	3,800	65
70							22.6	2,400	39.0	2,700	47.8	2,900	70
75							9.8	1,600	33.9	1,900	44.2	2,100	75
80							**		28.1	1,300	40.4	1,500	80

****MAXIMUM CAPACITY AT 0 DEGREE BOOM ANGLE**

BOOM LENGTH 35'		BOOM LENGTH 50'		BOOM LENGTH 65'		BOOM LENGTH 80'		BOOM LENGTH 95'		BOOM LENGTH 110'	
LOAD RADIUS (FT)	360° (LB)	LOAD RADIUS (FT)	360° (LB)	LOAD RADIUS (FT)	360° (LB)	LOAD RADIUS (FT)	360° (LB)	LOAD RADIUS (FT)	360° (LB)	LOAD RADIUS (FT)	360° (LB)
31.2	16,100	46.2	7,300	61.2	3,500	76.2	1,400				

USE THESE CHARTS ONLY WHEN ALL OUTRIGGERS ARE PINNED IN MID POSITION

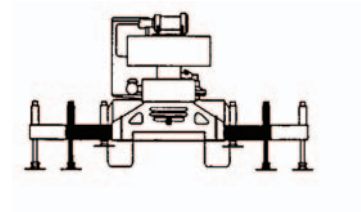



LIFTING CAPACITIES CAUTION: Do not use this specification sheet as a load rating chart. The format of data is not consistent with the machine chart and may be subject to change

ON OUTRIGGERS - RETRACTED

LOAD RADIUS (FT)	BOOM LENGTH 35'		BOOM LENGTH 50'		BOOM LENGTH 65'		BOOM LENGTH 80'		BOOM LENGTH 95'		BOOM LENGTH 100'		LOAD RADIUS (FT)
	BOOM ANGLE (DEG) REF.	360° (LB)	BOOM ANGLE (DEG) REF.	360° (LB)	BOOM ANGLE (DEG) REF.	360° (LB)	BOOM ANGLE (DEG) REF.	360° (LB)	BOOM ANGLE (DEG) REF.	360° (LB)	BOOM ANGLE (DEG) REF.	360° (LB)	
	10	66.7	67,000	73.9	60,100*								
12	63.1	46,800	71.5	48,000									12
15	57.5	30,900	67.9	32,100	73.2	32,600							15
20	47.1	17,900	61.5	19,300	68.5	19,700	72.7	20,000					20
25	34.5	11,200	54.8	12,600	63.7	13,200	68.9	13,400	72.3	13,600			25
30	14.8	7,000	47.4	8,500	58.6	9,200	65.0	9,500	69.1	9,600	72.1	9,700	30
35	**		39.0	5,700	53.3	6,400	61.0	6,800	65.9	6,900	69.3	7,100	35
40			28.8	3,700	47.6	4,400	56.8	4,800	62.5	5,000	66.5	5,100	40
45			12.4	2,100	41.3	2,900	52.4	3,300	59.1	3,500	63.6	3,700	45
50			**		34.1	1,700	47.7	2,100	55.5	2,400	60.7	2,500	50
55									51.7	1,400	57.7	1,600	55

****MAXIMUM CAPACITY AT 0 DEGREE BOOM ANGLE**

BOOM LENGTH 35'		BOOM LENGTH 50'		BOOM LENGTH 65'		BOOM LENGTH 80'		BOOM LENGTH 95'		BOOM LENGTH 100'	
LOAD RADIUS (FT)	360° (LB)	LOAD RADIUS (FT)	360° (LB)	LOAD RADIUS (FT)	360° (LB)	LOAD RADIUS (FT)	360° (LB)	LOAD RADIUS (FT)	360° (LB)	LOAD RADIUS (FT)	360° (LB)
31.2	6,000	46.2	1,700								

USE THESE CHARTS WHEN ALL OUTRIGGER BEAMS ARE NOT IN EITHER THE MID OR FULLY EXTENDED POSITION

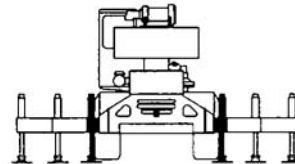



LIFTING CAPACITIES

CAUTION: Do not use this specification sheet as a load rating chart. The format of data is not consistent with the machine chart and may be subject to change

SIDE STOW JIB ON FULLY EXTENDED OUTRIGGERS

LOADED BOOM ANGLE (DEG)	32' OFFSETABLE JIB/NO PULL OUT INSTALLED						33' OFFSETABLE JIB/PULL OUT RETRACTED						57' OFFSETABLE JIB						LOADED BOOM ANGLE (DEG)
	0° OFFSET		15° OFFSET		30° OFFSET		0° OFFSET		15° OFFSET		30° OFFSET		0° OFFSET		15° OFFSET		30° OFFSET		
	LOAD RADIUS (REF) (FT)	360° (LB)	LOAD RADIUS (REF) (FT)	360° (LB)	LOAD RADIUS (REF) (FT)	360° (LB)	LOAD RADIUS (REF) (FT)	360° (LB)	LOAD RADIUS (REF) (FT)	360° (LB)	LOAD RADIUS (REF) (FT)	360° (LB)	LOAD RADIUS (REF) (FT)	360° (LB)	LOAD RADIUS (REF) (FT)	380° (LB)	LOAD RADIUS (REF) (FT)	360° (LB)	
75	38	12,100*	45	8,500*	52	6,600*	38	12,100*	46	8,500*	53	6,600*	46	6,100*	61	4,600*	71	3,400*	75
73	43	11,600*	50	8,200*	57	6,400*	44	11,600*	51	8,200*	58	6,400*	53	6,100*	66	4,400*	77	3,300*	73
71	49	11,100*	56	7,800*	62	6,300*	50	11,100*	57	7,800*	63	6,300*	59	5,900*	73	4,200*	83	3,200*	71
68	56	10,400*	63	7,400*	69	6,000*	57	10,400*	64	7,400*	70	6,000*	67	5,600*	80	3,900*	90	3,100*	68
65	63	9,600*	69	7,000*	75	5,900*	64	8,700*	70	7,100*	76	5,900*	75	5,200*	88	3,700*	96	3,000*	65
62	70	8,500	75	6,800*	80	5,700*	71	7,100	76	6,500	81	5,700*	84	4,800*	95	3,500*	102	2,900*	62
59	76	7,100	81	6,500	86	5,500*	78	6,100	83	5,600	87	5,200	93	4,500*	103	3,400*	108	2,800*	59
55	83	5,800	89	5,300	92	5,100	85	4,900	90	4,400	93	4,000	103	3,700	111	3,200*	114	2,700*	55
51	90	4,600	95	4,300	99	4,100	91	3,900	97	3,400	101	3,200	112	2,800	118	2,600	121	2,500*	51
47	97	3,800	102	3,600	105	3,400	98	3,000	103	2,700	107	2,600	120	2,200	125	2,100	128	2,000	47
43	103	3,100	108	3,000	111	2,900	104	2,100	110	2,100	112	2,100	128	1,700	132	1,600	135	1,500	43
38	111	2,400	115	2,300	117	2,200	112	1,500	117	1,600	118	1,500	135	1,200	139	1,100	142	1,100	38
32	119	1,700	122	1,800	124	1,700	120	1,000	123	1,000	125	1,000	143	700					32
25	126	1,200	129	1,200															25
17	133	800																	17

Notes For Jib Capacities:

- A. For all boom lengths less than the maximum with a jib erected, the rated loads are determined by boom angle only in the appropriate column.
- B. For boom angle not shown, use the capacity of the next lower boom angle.
- C. Listed radii are for extended main boom only.



LIFTING CAPACITIES

CAUTION: Do not use this specification sheet as a load rating chart. The format of data is not consistent with the machine chart and may be subject to change

ON TIRES

RADIUS (FT)	MAX BOOM LENGTH (FT)	21:00 X 25-28 PR				26.5 X 25-26 PR			
		STATIONARY		PICK & CARRY		STATIONARY		PICK & CARRY	
		STATIC		CREEP	2.5 MPH	STATIC		CREEP	2.5 MPH
		360°	STRAIGHT OVER FRONT			360°	STRAIGHT OVER FRONT		
10	35	46,600	74,000	56,300	47,600	41,200*	65,100*	49,300*	41,200*
12	35	31,200	64,400	48,800	41,100	34,600*	56,600*	42,500*	35,400*
15	35	19,800	53,600	40,200	33,600	22,900*	46,900*	34,900*	28,800*
20	35	12,800	33,000	30,300	25,000	14,800	31,600	26,000*	21,100*
25	50	8,900	20,800	20,800	19,200	9,600	20,800	20,000*	15,900*
30	50	5,200	13,300	13,300	13,300	6,200	14,300	14,300	12,100*
35	50	3,300	10,300	10,300	10,300	4,000	10,600	10,600	9,500*
40	50	2,200	8,000	8,000	8,000	2,700	8,000	8,000	7,700*
45	65	1,300	6,400	6,400	6,400	1,800	6,400	6,400	6,300*
50	65		5,200	5,200	5,200		5,200	5,200	5,100*
55	65		4,200	4,200	4,200		4,200	4,200	4,100*
60	80		3,200	3,200	3,200		3,200	3,200	3,200
65	80		2,400	2,400	2,400		2,400	2,400	2,400

Notes For Tire Capacities:

- A. For Pick and Carry operations, boom must be centered over the front of the crane with swing brake and lock engaged. Use minimum boom point height and keep load close to ground surface.
- B. The load should be restrained from swinging. NO ON TIRE OPERATION WITH JIB ERECTED.
- C. Without outriggers, never maneuver the boom beyond listed load radii for applicable tires to ensure stability.
- D. Creep speed is crane movement of less than 200' (61 m) in a 30 minute period and not exceeding 1.0 mph (1.6 km/h).
- E. Refer to General Notes for additional information.

RECOMMENDED TIRE PRESSURE

TIRE SIZE	STATIONARY	CREEP	2 1/2 MPH	TRAVEL
21:00 x 25-28 PR	85 PSI	85 PSI	85 PSI	65 PSI
26:50 x 25-26	65 PSI	65 PSI	65 PSI	50 PSI

MAXIMUM PERMISSIBLE HOIST LINE LOAD

LINE PARTS	1	2	3	4	5	6	7	8	9	10
MAIN & AUX. HOIST	11,250	22,500	33,750	45,000	56,250	67,500	78,750	90,000	101,250	112,500
WIRE ROPE:	5/8" ROTATION RESISTANT 34X7 COMPACTED STRAND, GRADE 2160, MINIMUM BREAKING STRENGTH - 28.2 TONS. 5/8" 6X19 OR 6X37, XIPS, IWRC, PERFORMED RIGHT REGULAR LAY MINIMUM BREAKING STRENGTH - 20.6 TONS. WEIGHT 1.04 LB/FT.									



General Notes | RT555-1 Series

GENERAL

1. Rated loads as shown on Lift Charts pertain to this machine as originally manufactured and equipped. Modifications to the machine or use of optional equipment or other than that specified can result in a reduction of capacity.
2. Construction equipment can be hazardous if improperly operated or maintained. Operation and maintenance of this machine shall be in compliance with the information in the Operator's, Parts and Safety Manuals supplied with this machine. If These manuals are missing, order replacements from the manufacturer through your distributor.
3. These warnings do not constitute all of the operating conditions for the crane. The operator and job site supervision must read the OPERATORS MANUAL, CIMA SAFETY MANUAL, APPLICABLE OSHA REGULATIONS, AND SOCIETY OF MECHANICAL ENGINEERS (ASME) SAFETY STANDINGS FOR CRANES.
4. This crane and its load ratings are in accordance with POWER CRANE & SHOVEL ASSOCIATION, STANDARD NO.4 SAE CRANE LOAD STABILITY TEST CODE J765A, SAE METHOD OF TEST FOR CRANE STRUCTURE J1063 AND APPLICABLE SAFETY CODE FOR CRANES, DERRICKS AND HOISTS, ASME/ANSI B30.5

DEFINITIONS

1. **LOAD RADIUS** - The horizontal distance from the axis of rotation before loading to the center of the vertical hoist line or tackle with a load applied.
2. **LOADED BOOM ANGLE** - It is the angle between the boom base section and the horizontal, after lifting the rated load at the rated radius. The boom angle before loading should be greater to account for deflections. The loaded boom angle combined with boom length give only an approximation of the operating radius.
3. **WORKING AREA** - Areas measured in a circular arc about the centerline of rotation as shown in the diagram.
4. **FREELY SUSPENDED LOAD** - Load hanging free with no direct external force applied except by the hoist rope.
5. **SIDE LOAD** - Horizontal force applied to the lifted load either on the ground or in the air.
6. **NO LOAD STABILITY LIMIT** - The stability limit radius shown on the range diagrams is the radius beyond which it is not permitted to position the boom, when the boom angle is less than the minimum shown on the applicable load chart, because the machine can overturn without any load.
7. **BOOM SIDE OF CRANE** - The side of the crane over which the boom is positioned when in OVER SIDE working position.

SET-UP

1. Crane load ratings are based on the crane being leveled and standing on a firm, uniform supporting surface.
2. Crane load ratings on outriggers are based on all outrigger beams being fully extended or in the case of partial extension ratings mechanically pinned in the appropriate position, and the tires free of the supporting surface.
3. Crane load ratings on tires depend on appropriate inflation pressure and the tire conditions. Caution must be exercised when increasing air pressures in tires. Consult Operator's Manual for precautions.
4. Use of jibs, lattice-type boom extensions, or fourth section pullouts extended is not permitted for pick and carry operations.
5. Consult appropriate section of the Operator's and Service Manual for more exact description of hoist line reeving.
6. The use of more parts of line than required by the load may result in having insufficient rope to allow the hook block to reach the ground.
7. Properly maintained wire rope is essential for safe crane operation. Consult Operator's Manual for proper maintenance and inspection requirements.
8. When spin-resistant wire rope is used, the allowable rope loading shall be the breaking strength divided by five (5), unless otherwise specified by the wire rope manufacturer.
9. Do not elevate the boom above 60° unless the boom is positioned in-line with the crane's chassis or the outrigger are extended. Failure to observe this warning may result in loss of stability.

OPERATION

1. **CRANE LOAD RATINGS MUST NOT BE EXCEEDED. DO NOT ATTEMPT TO TIP THE CRANE TO DETERMINE ALLOWABLE LOADS.**
2. When either radius or boom length, or both, are between listed values, the smaller of the two listed load ratings shall be used.
3. Do not operate at longer radii than those listed on the applicable load rating chart (cross hatched areas shown on range diagrams.)
4. The boom angles shown on the Capacity Chart give an approximation of the operating radius for a specified boom length. The boom angle, before loading, should be greater to account for boom deflection. It may be necessary to retract the boom if maximum boom angle is insufficient to maintain rated radius.
5. Power telescoping boom sections must be extended equally.
6. Rated loads include the weight of hook block, slings, and auxiliary lifting devices. Their weights shall be subtracted from the listed rated load to obtain the net load that can be lifted. When lifting over the jib the weight of any hook block, slings, and auxiliary lifting devices at the boom head must be added to the load. When jibs are erected but unused add two (2) times the weight of any hook block, slings, and auxiliary lifting devices at the jib head to the load.
7. Rated loads do not exceed 85% on outriggers or 75% on tires, of the tipping load as determined by SAE Crane Stability Test Code J765a. Structural strength ratings in chart are indicated with an asterisk (*).
8. Rated loads are based on freely suspended loads. No attempt shall be made to drag a load horizontally on the ground in any direction.
9. The user shall operate at reduced ratings to allow for adverse job conditions, such as: soft or uneven ground, out of level conditions, high winds, side loads, pendulum action, jerking or sudden stopping of loads, hazardous conditions, experience of personnel, two machine lifts, traveling with loads, electric wires, etc. (side pull on boom or jib is hazardous). Derating of the cranes lifting capacity is required when wind speed exceeds 20 MPH. The center of the lifted load must never be allowed to move more than 3' off the center line of the base boom section due to the effects of wind, inertia, or any combination of the two.
Use 2' off the center line of the base boom for a two section boom, 3' for a three section boom, or 4' for a four section boom.
10. The maximum load which can be telescoped is not definable, because of variations in loadings and crane maintenance, but it is permissible to attempt retraction and extension if load ratings are not exceeded.
11. Load ratings are dependent upon the crane being maintained according to manufacturer's specifications.
12. It is recommended that load handling devices, including hooks, and hook blocks, be kept away from boom head at all times.
13. **FOR TRUCK CRANES ONLY:** 360° capacities apply only to machines equipped with a front outrigger jack and all five(5) outrigger jacks properly set. If the front (5th) outrigger jack is not properly set, the work area is restricted to the over side and over rear areas as shown on the Crane Working Positions diagram. Use the 360° load ratings in the overside work areas.
14. Do not lift with outrigger beams positioned between the fully extended and intermediate (pinned) positions.
15. Truck Cranes not equipped with equalizing (bogie) beams between the rear axles may not be used for lifting "on tires". Truck Cranes equipped with equalizing beams and rear air suspension should "dump" the air before lifting "on tires".

CLAMSHELL, MAGNET, AND CONCRETE BUCKET SERVICE

1. Maximum boom length for clamshell and magnet service is 50'.
2. Weight of clamshell or magnet, plus contents are not to exceed 6,000 lb or 90% of rated lifting capacities, whichever is less. For concrete bucket operation, weight of bucket and load must not exceed 90% of rated lifting capacity.

TEREX Cranes
106-12th Street S.E.
Waverly, Iowa 50677-9466 USA

TEL (319) 352-3920 FAX (319) 352-5727
EMAIL inquire@terexwaverly.com
WEB terex.com

WE RESERVE THE RIGHT TO AMEND THESE SPECIFICATIONS AT ANY TIME WITHOUT NOTICE. THE ONLY WARRANTY APPLICABLE IS OUR STANDARD WRITTEN WARRANTY APPLICABLE TO THE PARTICULAR PRODUCT AND SALE. WE MAKE NO OTHER WARRANTY, EXPRESSED OR IMPLIED.